

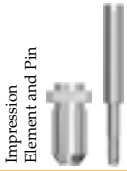















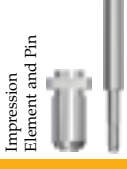







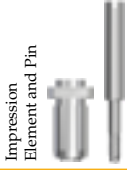







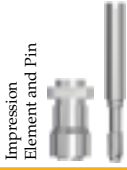

Cresco API™ for Camlog®

Implant Ø 3.3 mm Grey		Cresco API™	REF 30331	REF 30531	REF 30831		
Prosthetic Components		Laboratory Components		Includes Bridge Support in			
Impression Element and Pin 	Bridge Screw 	Replica 	Process Screw 	Wax Tube 	Titanium 	Burnout 	Cobalt-Chrome 

Implant Ø 3.8 mm Yellow		Cresco API™	REF 30332	REF 30532	REF 30832		
Prosthetic Components		Laboratory Components		Includes Bridge Support in			
Impression Element and Pin 	Bridge Screw 	Replica 	Process Screw 	Wax Tube 	Titanium 	Burnout 	Cobalt-Chrome 

Implant Ø 4.3 mm Red		Cresco API™	REF 30333	REF 30533	REF 30833		
Prosthetic Components		Laboratory Components		Includes Bridge Support in			
Impression Element and Pin 	Bridge Screw 	Replica 	Process Screw 	Wax Tube 	Titanium 	Burnout 	Cobalt-Chrome 

Implant Ø 5.0 mm Blue, 6.0 mm Green		Cresco API™	REF 30334	REF 30534	REF 30834		
Prosthetic Components		Laboratory Components		Includes Bridge Support in			
Impression Element and Pin 	Bridge Screw 	Replica 	Process Screw 	Wax Tube 	Titanium 	Burnout 	Cobalt-Chrome 

Cresco™ restorative instruments for Camlog®

Screwdrivers

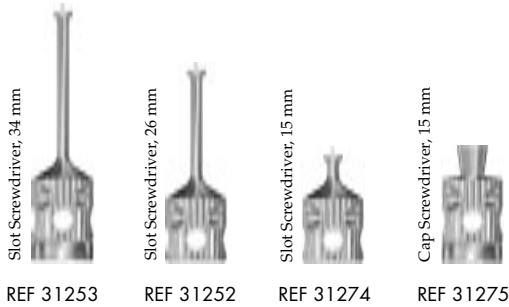

REF 31254

Slot Screwdriver, Long

RA Screwdrivers

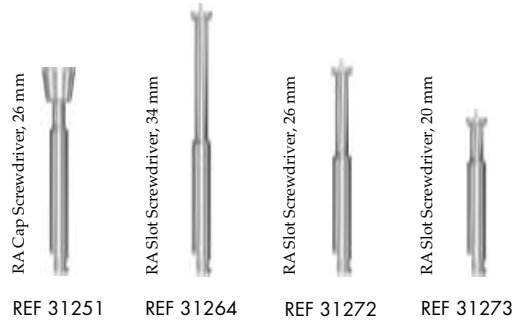

Instruments

REF 31276



Torque Ratchet Wrench with individual adjustment of the torque to 15, 20 and 35 Ncm

REF 31248



Counter Torque Key, flat grip

REF 22437



Forceps titanium, 94 mm

Camlog® is a registered trademark of Camlog Biotechnologies AG, Basel, Switzerland.

Cresco™ and Cresco API™ are trademarks of Astra Tech AB, Sweden.